

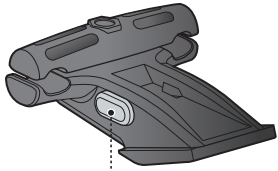

EN DE FR ES IT PL JP KR CH

### DUO FIXER QuickClick®



### Release button

Entriegelungsknopf  
bouton de déverrouillage  
Botón de liberación  
Pulsante di rilascio  
Przycisk zwalniający  
リリースボタン  
해제 버튼  
快放鈕

### Low Battery Power Indicator

Niedrige Akku-  
Ladestandanzeige  
Indicateur de  
batterie faible  
Indicador de  
batería baja  
Indicatore di  
batteria scarica

Wskaźnik  
zużycia baterii  
容量低下警告  
インジケーター  
배터리 전원 부족  
표시등  
弱電顯示

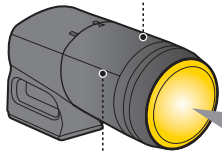

**Charge Indicator**  
Akku-Ladestandanzeige  
indicateur de charge  
Indicador de carga  
Indicatore di carica  
Wskaźnik ładowania  
充電インジケーター  
충전 표시등  
充電顯示

### MODE MODUS / MODE / MODO / MODALITA' /

TRYB / 機能 / 작동순서 / 模式

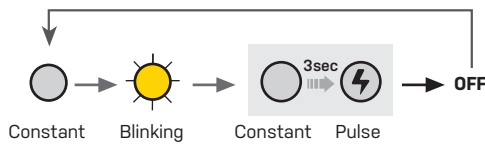

Constant Blinking Constant Pulse OFF

### Push lens to turn on/off and switch modes

Auf die Linse  
drücken, um das  
Licht an- oder  
auszuschalten und  
den Modus zu  
wechseln

Pousser la  
lentille pour  
allumer/éteindre  
et changer les  
modes  
d'éclairage

Apretar lente  
para modos  
encender/  
apagar

Premere la luce  
per accendere  
e spegnere o  
per cambiare  
modalità

Naciśnij  
soczewkę, aby  
wł./wył.  
światło oraz  
przejsć w inny  
tryb

렌즈를 누르면  
켜짐/꺼짐  
스위치모드로  
전환됩니다

電源開 / 關  
與照明模式選  
擇鈕

### Press and hold for 3 seconds to turn off in any mode

3 Sekunden  
gedrückt halten,  
um die Lampe in  
jedem Modus  
auszuschalten

maintenir le  
bouton 3  
secondes pour  
éteindre les  
modes

Pulsar durante  
3 segundos  
para apagar en  
cualquier modo

Tenere premuto  
per 3 secondi  
per spegnere la  
luce in ogni  
modalità

Naciśnij i  
przytrzymaj 3  
s. aby  
wyłączyć  
każdy tryb

3秒間長押しで  
どのモードから  
でもOFFにな  
ります

모드에 상관없이  
3초간 길게  
누르고 있으면  
전원이 꺼집니다

在任何模式下  
按壓3秒即可  
關閉電源

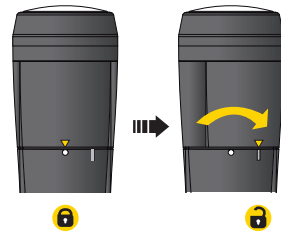

**Twist to unlock and release**  
Zum Entriegeln und Lösen drehen  
Faire tourner pour débloquent  
Girar para desbloquear y soltar  
Ruotare per sbloccare e rilasciare

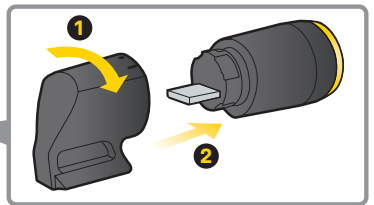

Przekręć, aby odblokować i uwolnić  
図のように回転させて取り外します  
돌려서 잠금 해제 및 잠금 설정  
轉向取下防塵蓋

### DUO FIXER AND TAILLUX INSTALLATION

### BEFESTIGUNG VON DUO FIXER & TAILLUX / INSTALLATION DU DUO FIXER ET DU TAILLUX / INSTALACIÓN DE DUO

### FIXER Y TAILLUX / MONTAGGIO DUO FIXER E TAILLUX / MONTAŻ DUO FIXER I TAILLUX / デュオフィクサーとテールルクスの取付 / DUO FIXER과 TAILLUX 장착 방법 / DUO FIXER 與尾燈安裝步驟說明

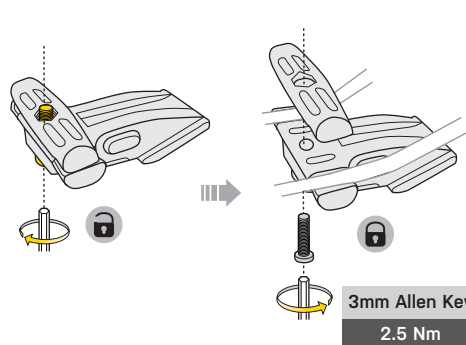

3mm Allen Key  
2.5 Nm

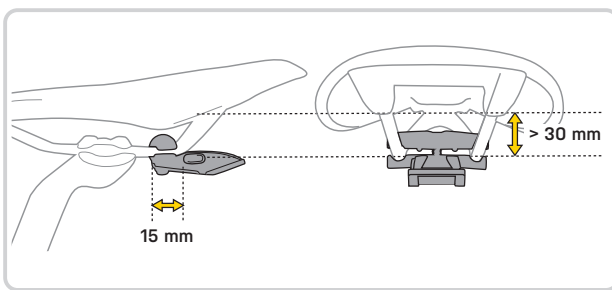

15 mm

> 30 mm

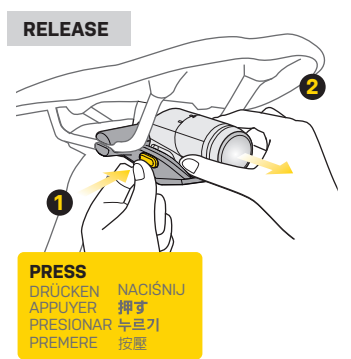
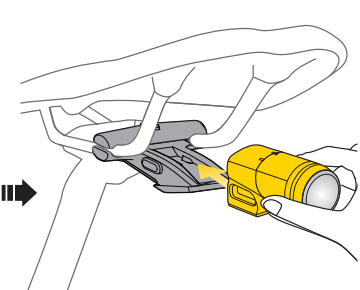

### RELEASE

**PRESS**  
DRÜCKEN  
APPUYER  
押す  
PRESIONAR  
누르기  
PREMERE  
按壓

**NACIŚNIJ**  
DRÜCKEN  
APPUYER  
押す  
PRESIONAR  
누르기  
PREMERE  
按壓

### SADDLE COMPATIBILITY / SATTELKOMPATIBILITÄT / COMPATIBILITÉ SELLE / COMPATIBILIDAD CON EL SILLÍN / COMPATIBILITÀ SELLA / KOMPATYBILNY Z SIODŁAMI / サドルの互換性 / 안장 호환성 / 座椅適用性

**Works with**  
• Standard saddle rail with 36mm spacing  
• Carbon, Steel, CrMo, Titanium saddle rails

Kompatibel mit:  
• Standard-Sattelgestellen mit 36 mm Abstand  
• Sattelgestellen aus Carbon, Stahl, CrMo & Titan

Marche avec  
• Rail de selle standard avec espacement de 36 mm  
• Rails de selle Carbone, Acier, CrMo, Titane

Válido para  
• Rail de sillín estándar con espacio de 36 mm  
• Rails de carbono, acero, CrMo, titanio

Compatible con:  
• Carrello sella standard con 36mm di spazio  
• Carrelli sella in carbonio, acciaio, CrMo e titanio

Działa z  
• Standardowe pręty z rozstawem 36mm  
• Pręty karbonowe, stalowe, CrMo, tytanowe

対応サドル  
• レール内幅36mm  
• カーボン、スチール、クロモリ、チタン製レール

장착 가능  
• 36mm 간격  
표준 안장 레일  
• 카본, 스틸, 크로몰리, 티타늄 안장 레일

可適用  
• 標準坐墊、坐弓  
間距36mm  
• 碳、鋼、鉻鉬鋼、鈦之坐弓



X

### Monorail saddle

Sattel mit Monorail  
Selle monorail  
Sillín monorail  
Sella monobinario  
Siódła Monorail  
모노(단일)레일 안장  
單弓坐墊



X

### Saddle with rear bumper

Sattel mit Dämpfern  
Selle avec amortisseur arrière  
Sillín con amortiguación trasera  
Sella con paraurti posteriore  
Siódła z elastomerem  
リアバンパー付サドル  
후방 범퍼가 있는 안장  
帶後避震的坐墊



X

### Saddle with rear spring

Sattel mit Federn  
Selle avec ressort arrière  
Sillín con muelle trasero  
Sella con molla posteriore  
Siódła ze sprężyną  
리아스프링付サドル  
후방 스프링 있는 안장  
帶後彈簧的坐墊



### DUO FIXER MOUNTING SYSTEM

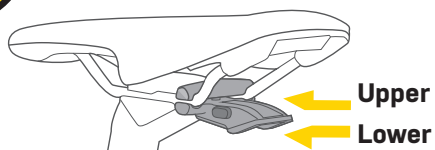

Upper  
Lower

### DOUBLE USE

with DF series accessories

Zwei Aufnahmen für Zubehör der DF-Serie  
Double utilisation avec les accessoires de la série DF

Doble uso con los accesorios de la serie DF

Doppio utilizzo con la serie accessori DF

Podwójne zastosowanie z akcesoriami serii DF

DFシリーズアクセサリを2個取付可能

DF 시리즈 액세서리와 함께 사용가능

與DF系列配件共同使用



SCAN TO DISCOVER MORE  
ABOUT DF SYSTEM &  
ACCESSORIES

### TUBI TOOL / CO2

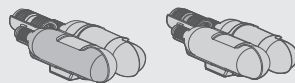

TubiMaster GX DF NanoMaster DF

### LIGHT

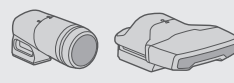

TailLux 40 DF TailLux 25 DF

### FENDER



FLASHFENDER DF

1 >>>

2 >>>

### STRAP / TIRE LEVER

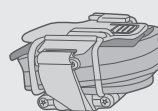

FreePack

### FENDER

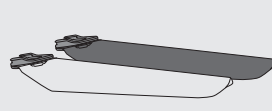

FLASHFENDER DF Deluxe

### CO2 / PUMP

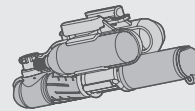

HybridMaster DF

### QUICKCLICK SADDLE BAG

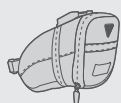

Aero Wedge Pack series

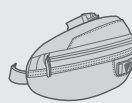

Wedge Pack II Series

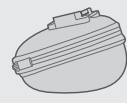

ProPack Series



Wedge DryBag

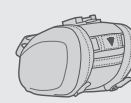

SideKick Wedge Pack Series



MondoPack Series



# TAILLUX 40 DF

PREPARE TO RIDE

## CABLE-FREE CHARGING KABELLOSES LADEN / RECHARGE SANS CÂBLE / CARGA SIN

CABLE / RICARICA SENZA CAVO / ŁADOWANIE BEZPRZEWODOWE / 充電方法 / 케이블이 필요없는 USB 충전 단자 / 充電說明

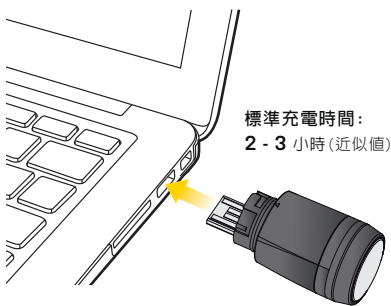

標準充電時間:  
2 - 3 小時 (近似值)

**USB Insertion Tab**  
USB-Ladeanschluss  
Prise USB  
Pestaña de inserción USB  
Attacco USB  
Wtyczka USB  
USB 端子  
USB 충전 단자  
連接電腦或  
USB 電源轉換器

<b>Standard charging time</b> 2 - 3 hours (approx)	<b>Ricarica standard</b> 2 - 3 ore (circa)
<b>Standard Ladezeit</b> 2 - 3 Stunden (ca.)	<b>Średni czas ładowania</b> 2 - 3 godziny (około)
<b>Temps de charge standard</b> +/- 2-3 heures	<b>充電時間</b> 約 2 - 3 時間
<b>Tiempo de carga</b> 2 - 3 h (aprox)	<b>일반적인 충전 시간</b> 2 - 3 시간 (근사치)

## SPECIFICATIONS SPEZIFIKATIONEN / SPÉCIFICATIONS / ESPECIFICACIONES / SPECIFICHE / SPECYFIKACJA / スペック / 제품 사양 / 規格說明

<b>Burn Time</b> : Constant - 10 lm (3.5 hr) Blink - 10 lm (40 hr) Pulse - 40 lm (20 hr)	<b>Leuchtdauer</b> : Konstant - 3,5 h (10 lm) Blinken - 40 h (10 lm) Pulsierend - 20 h (40 lm)	<b>Autonomie</b> : constant 10 Lm (3,5 heures) clignotant 10 Lm (40 heures) pulse 40 L m (20hr)	<b>Duración</b> : Constante - 10 lm (3.5 hr) Intermitente - 10 lm (40 hr) Pulso - 40 lm (20 hr)	<b>Modalità - Durata</b> : Fissa - 10 lm (3.5 ore) Intermittenza - 10 lm (40 ore) Pulsazione - 40 lm (20 ore)
<b>Luminous Flux</b> : 40 Lumens <b>Input</b> : 5V 500mA <b>Lamp</b> : Super bright red LED's <b>Battery</b> : 3.7V 160mAh Lithium Ion (integrated) <b>Charge</b> : USB-A / 2 hr <b>Weight</b> : 30 g	<b>Lichtstrom</b> : max. 40 Lumen <b>Input</b> : USB-A, 5V 500mA <b>Leuchtmittel</b> : Super helle LEDs (rot) (integriert) <b>Akku</b> : 3,7V 160mA Lithium-Ionen (integriert) <b>Gewicht</b> : 30 g	<b>Puissance</b> : 5V 500mA <b>Ampoule</b> : Led Rouge "super bright" <b>Batterie</b> : 3,7V 160mAh lithium Ion (intégrée) <b>Chargeur</b> : USB-A / 2 heures <b>Poids</b> : 30 g	<b>Luminosidad</b> : 40 lúmenes <b>Entrada</b> : 5V 500mA <b>Lámpara</b> : LED roja súper brillante <b>Batería</b> : 3.7V 160mAh Ion de Litio (integrada) <b>Carga</b> : USB-A / 2 hr <b>Peso</b> : 30 g	<b>Flusso luminoso</b> : 40 Lumens <b>Input</b> : 5V 500mA <b>Luce</b> : LED rosso super luminoso <b>Batteria</b> : 3.7V 160mAh ioni di litio (integrata) <b>Carica</b> : USB-A / 2 ore <b>Peso</b> : 30 g

<b>Czas świecenia</b> : Stały - 10 lm (3,5 godz.) Miganie - 10 lm (40 godz.) Pulsacyjny - 40 lm (20 godz.) <b>Strumień świetlny</b> : 40 lumenów <b>Węjscie</b> : 5V 500mA <b>Lampa</b> : Super jasne czerwone diody LED <b>Bateria</b> : litowo-jonowa 3,7 V 160 mAh (zintegrowana) <b>Ładowanie</b> : USB-A / 2 godz. <b>Waga</b> : 30g	<b>点灯時間</b> : 点灯 - 10ルーメン (3.5 時間) 点滅 - 10ルーメン (40 時間) パルス点灯 - 40ルーメン (20 時間) <b>光束</b> : 40 ルーメン <b>入力</b> : 5V 500mA <b>LED</b> : 高輝度 レッドLED <b>バッテリー</b> : 3.7V 160mAh リチウムイオン内蔵 <b>充電時間</b> : USB-A / 2時間 <b>重量</b> : 30 g	<b>사용시간</b> : 지속 - 10 lm (3.5 시간) 점멸 - 10lm(40시간) 느린 점멸 - 40lm(20시간) <b>밝기</b> : 40루멘 <b>입력 장치</b> : 5V 500mA <b>램프</b> : 슈퍼 라이트 레드 LED <b>배터리</b> : 3.7V 160mAh 리튬 이온(통합형) <b>충전</b> : USB-A / 2시간 <b>중량</b> : 30g	<b>使用時間</b> : 恒亮10流明(3.5小時) 閃爍10流明(30小時) 節奏40流明(40小時) <b>發光流明</b> : 40流明 <b>輸入</b> : 5V 500mA <b>光源</b> : LED <b>電池</b> : 3.7V 160mAh鋰電池 <b>充電</b> : USB-A/2小時 <b>重量</b> : 30g	
--	--	---	--	--

- The TAILLUX 40 DF Charge Indicator will be lit GREEN when charging. LED will turn off when battery is fully charged.
- The TAILLUX 40 DF Charge Indicator will be lit RED when the remaining battery power is low. Please charge the light as soon as possible.
- The TAILLUX 40 DF LED will not illuminate if the battery is faulty.
- After TAILLUX 40 DF is fully charged, unplug the USB port.
- Do not open light body.
- Battery may take 3 to 5 charging cycles to attain full capacity.
- Do not leave battery connected to charge source over 48 hours continuously.
- Charging with USB hub will take longer.
- After long periods of non-use, the battery will lose charge. Always charge the battery fully before each use and storage.
- Maintain the battery by charging it every two months and storing it in a cool, dry place to prevent from decreasing its lifespan.
- Safely and properly dispose of the light body according to your local regulations.
- Please use the charger as the specification shown on the user's guide. Do not use quick charger, otherwise it might cause damage.

- L'indicateur de carica di TAILLUX 40 DF sarà VERDE durante la carica. Il LED si spegnerà quando la batteria sarà completamente carica.
- L'indicateur de carica di TAILLUX 40 DF sarà ROSSO quando il livello di batteria residua è basso. Si prega di ricaricare la luce il prima possibile.
- Il LED di TAILLUX 40 DF non si accenderà se la batteria è guasta.
- Quando la ricarica di TAILLUX 40 DF è completa, staccare il cavo USB dalla porta.
- Non aprire il corpo della luce.
- La batteria potrebbe impiegare dai 3 ai 5 cicli di ricarica per raggiungere la massima autonomia.
- Non lasciare la batteria connessa alla sorgente di ricarica per più di 48 ore consecutive.
- Il tempo di ricarica via hub USB è più lungo.
- Dopo lunghi periodi di inutilizzo, la batteria inizierà a perdere autonomia. Ricaricare sempre la batteria completamente prima di ogni uso e prima di riparla.
- Preservare la batteria caricandola almeno ogni due mesi e riponendola in un luogo fresco e asciutto per prevenire la riduzione del suo ciclo di vita.
- Smaltire in sicurezza e in modo appropriato il corpo della luce in accordo con le tue leggi locali.
- Si prega di utilizzare il caricatore come specificato nella guida utente. Non utilizzare caricatori rapidi, potrebbero causare danni.

<b>WARRANTY</b> 1-year Warranty against manufacturer defects only. (Batteries are not covered under any implied warranty.) <b>Warranty Claim Requirements</b> To obtain warranty service, you must be the original owner and provide proof of purchase. Items returned without a sales receipt will assume that the warranty begins on the date of manufacture. All warranties will be void if the product is damaged due to user crash, abuse, system alteration, modification, or used in any way not intended as described in this manual. * The specifications and design are subject to change without notice. <b>Please contact your Topeak dealer with any questions. For USA customer service, call: 1-800-250-3068 www.topeak.com</b>	<b>GEWÄHRLEISTUNG</b> <b>Gewährleistungsanspruch</b> Sie benötigen Ihren Originalkaufbeleg um den Gewährleistungs-Service zu erhalten. Bei Artikel die ohne Kaufbeleg eingedient werden, wird davon ausgegangen, dass die Gewährleistung mit dem Herstellungsdatum beginnt. Alle Gewährleistungsansprüche werden ungültig, wenn der Artikel auf Grund eines Unfalls beschädigt oder zweckentfremdet wurde. Systemänderungen oder andere Veränderungen vorgenommen wurden oder der Artikel anderweitig verwendet wurde als in diesem Handbuch beschrieben. * Änderungen in Design und Eigenschaft bedürfen keiner vorherigen Ankündigung. <b>Topeak Produkte sind ausschließlich im Fahrradfachhandel erhältlich. Bitte nehmen Sie Kontakt mit Ihrem nächsten Topeak Händler auf, um offene Fragen zu klären. Für Kunden in Deutschland, Tel. 0261-899998-28/ Homepage: www.topeak.com</b>	<b>GARANTIE</b> Garantie de 1 an toutes parties mécaniques contre tout défaut de fabrication. (Les batteries ne sont pas couvertes par la garantie.) <b>Réclamation de la garantie</b> Pour bénéficier de notre service de garantie, vous devez être en possession de la facture d'achat originale. Si le produit nous est retourné sans cette facture d'achat, nous considérons la date de fabrication comme début de la garantie. Toute garantie sera considérée comme nulle si le produit a été endommagé suite à une chute, à un abus, une surcharge, à un quelconque changement ou modification ou à une utilisation autre que celle décrite dans ce manuel. * Les spécifications et l'apparence peuvent être sujettes à certaines modifications. <b>Contactez votre revendeur Topeak si vous avez la moindre question. For USA customer service, call : 1-800-250-3068 www.topeak.com</b>	<b>GARANTÍA</b> Garantía de 1 año únicamente para productos con defectos de fabricación. (Las baterías no están cubiertas por ninguna garantía implícita.) <b>Requisitos para la reclamación de garantía</b> Para obtener el servicio de garantía, debe ser el propietario original y proporcionar un comprobante de compra. Los artículos devueltos sin un recibo de compra comenzarán la garantía en la fecha de fabricación. Todas las garantías quedarán anuladas si el producto se daña debido a un accidente del usuario, abuso, alteración del sistema, modificación o uso de cualquier forma diferente a la descrita en este manual. * Las especificaciones y el diseño están sujetos a cambios sin previo aviso. <b>Póngase en contacto con su distribuidor Topeak si tiene alguna pregunta. Para llamar al servicio de atención al cliente de EE. UU.: 1-800-250-3068 www.topeak.com</b>	<b>GARANZIA</b> 1 anno di garanzia solo per difetti di produzione. (Le batterie non sono coperte da garanzia.) <b>Condizioni di garanzia</b> Per usufruire della garanzia è necessario essere il primo proprietario dell'articolo e fornire lo scontrino originale di acquisto. In caso il prodotto ci venga restituito senza lo scontrino la garanzia decorrerà dalla data di fabbricazione. La garanzia decade qualora il prodotto venga danneggiato da uso improprio, sovraccarico, modifiche o utilizzato in maniera diversa da quella descritta in questo manuale. * Le caratteristiche del prodotto possono essere cambiate senza preavviso. <b>I prodotti Topeak sono in vendita nei negozi specializzati per ciclisti. Per ogni richiesta o chiarimento rivolgetevi al rivenditore Topeak più vicino. Sito web: www.topeak.com</b>
---	--	--	---	---

<b>GAWARANCJA</b> 1rok gwarancji: Na wady fabryczne. (Baterie nie są objęte żadną dorozumianą gwarancją.) <b>Warunki korzystania z gwarancji</b> Aby uzyskać serwis gwarancyjny, należy być pierwszym właścicielem i posiadać dowód zakupu. Gdy produkt reklamowany jest bez paragonu zakładamy, że gwarancja rozpoczyna się od daty produkcji. Wszystkie gwarancje są nieważne jeśli produkt został uszkodzony na skutek wypadku, nadużycia, zmiany, modyfikacji lub wykorzystywany w jakkolwiek sposób niezgodny z opisanym w niniejszej instrukcji. * Specyfikacja i projekt mogą ulec zmianie bez powiadomienia. <b>W przypadku jakichkolwiek pytań skontaktuj się ze sprzedawcą lub importerem Topeak.</b>	<b>保証期間</b> ご購入日より1年間。製造上の欠陥による機械部品の不良が対象です。(バッテリーは保証の対象になりません。) <b>保証の請求</b> 保証を受けるには、ご購入の日付の入った領収書が必要です。領収書なしで保証を受ける場合の保証期間は製造年月日から起算させていただきます。お客様の事故などによる外的要因、誤使用、改造、およびこの取扱説明書に従わない本来の用途以外のご使用による故障は保証を受けられません。故障した製品は故障状況を明記して、お買い上げの販売店へお持ちください。お送りになる場合の送料はお客様にて負担をお願いします。 *スペックやデザインは改良のため予告なく変更されることがあります。 ご質問は、最寄りのトピーク正規販売店へどうぞ。 Website : www.topeak.jp	<b>품질보증</b> 제한적 1년 품질 보증 / 소비자 과실을 제외한 제조과정상 결함에 대하여 1 년간 보증합니다. (배터리 보증 제외) 품질 보증을 위한 필요조건 품질 보증 서비스를 받으시려면, 반드시 원본 구매 영수증을 제시해야 합니다. 구매 영수증이 없는 경우, 모든 제품은 그 제품의 가장 최초 제조일로부터 3개월 후를 구입일로 인정합니다. 외부 손상, 사용자의 오용, 남용, 임의 개조, 변경 또는 사용설명서에 기술한 내용에 맞지 않게 사용된 경우 품질 보증을 받을 수 없습니다. * 제품의 제원이나 디자인은 사전공지 없이 변경될 수 있습니다. 국내 전문 대리점을 통해 구입 가능합니다. 홈페이지 : www.hlsc.co.kr, www.topeak.com	<b>產品保固</b> 保固要求 申請保固期限中的服務，須檢具購買時之發票，若無法提供，則其保固期限將自製造日期開始算起。若因使用者不慎摔壞、使用不當、自行改裝、更改系統或未能按照說明書上的正確操作方式，本產品將不被列入保固範圍。 * 本公司保留產品規格變更之權利。 <b>Topeak 產品相關的資訊，請洽詢 Topeak 當地授權的經銷商</b> 網址 : www.topeak.com
--	--	---	--